

PRODUCT SPECIFICATIONS

STYLE # D8-1003

SERIES NAME: KUBIK

COLOR / FINISH: Gray Metal

DIFFUSER: Blown White Matte Glass

LAMP TYPE: Halogen G9 Frost 

MAX WATT: 1 x 75W

DIMENSIONS: D. 5 1/2" x Ht. 27 1/2" - 51 1/4"

APPROVALS: Approved by CSA for
North American Standards.

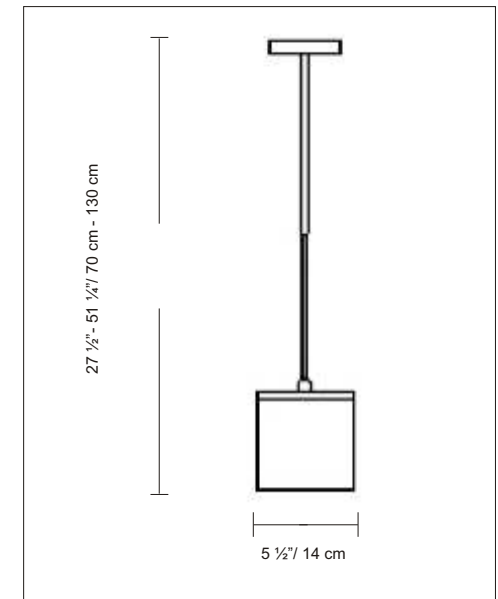

NOTES: _____