

Product Features

- Thermostatic temperature control and volume control in one unit
- 100° Safety stop
- Integrated three-way diverter – controls three functions
- Function 1 can only be used individually, functions 2 and 3 can be used individually or simultaneously
- High temperature limit stop may be reset to comply with local plumbing codes
- Flow rate 6.0 gpm @ 44 psi

Available Finishes

Chrome	32318000
Brushed Nickel	32318820

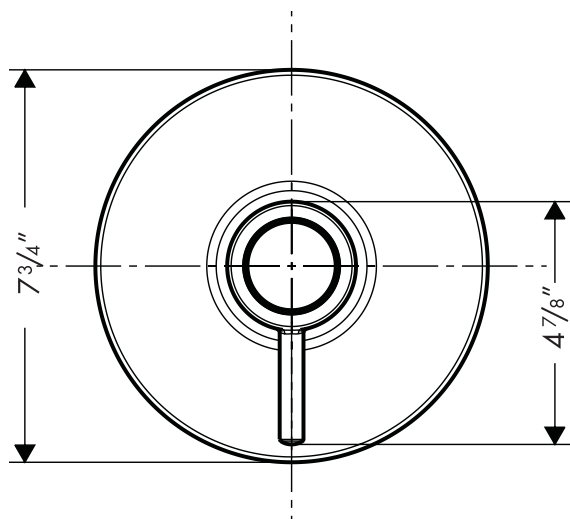

Required Accessories

ThermoBalance III rough	06624000
or	
ThermoBalance III rough with stops	06628000

The measurements shown are for reference only.

Products and specifications shown are subject to change without notice.

Specification sheet revised 2/2008