

Product Features

- Thermostatic temperature control and volume control in one unit
- Controls one function
- 100° Safety stop
- High temperature limit stop may be reset to comply with local plumbing codes
- Flow rate 9.5 gpm @ 44 psi when used with rough 06622 or 06621
- Flow rate 6.0 gpm @ 44 psi when used with rough 06300 or 06301

Available Finishes

Chrome	32316000
Brushed Nickel	32316820

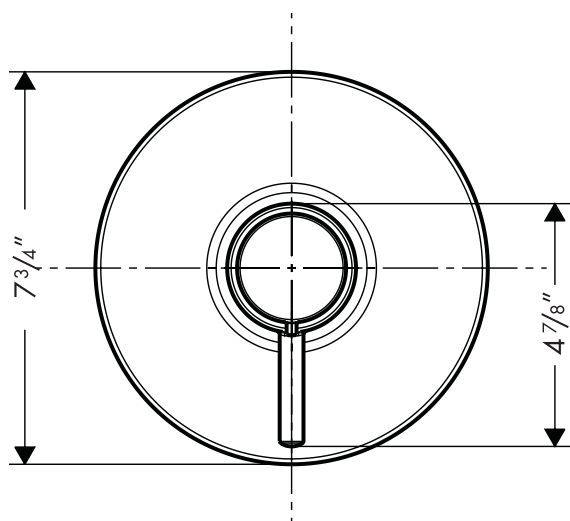

Required Accessories

ThermoBalance I rough	06622000
or	
ThermoBalance I rough with stops	06621000
or	
ThermoBalance I rough with bypass	06300000
or	
ThermoBalance I rough with bypass and stops	06301000

The measurements shown are for reference only.

Products and specifications shown are subject to change without notice.

Specification sheet revised 2/2008