

Product Features

- Solid brass
- Single-hole mount
- Single handle with M2 ceramic cartridge
- 2.2 gpm
- Includes pop-up drain

Code Compliance

This unit meets or exceeds the following:

- ADA compliant

Available Finishes

Chrome

31701001

Installation Notes

- 3/8" supply hoses - requires 3/8" compression fittings

Optional Accessories

6" baseplate

06490XX0

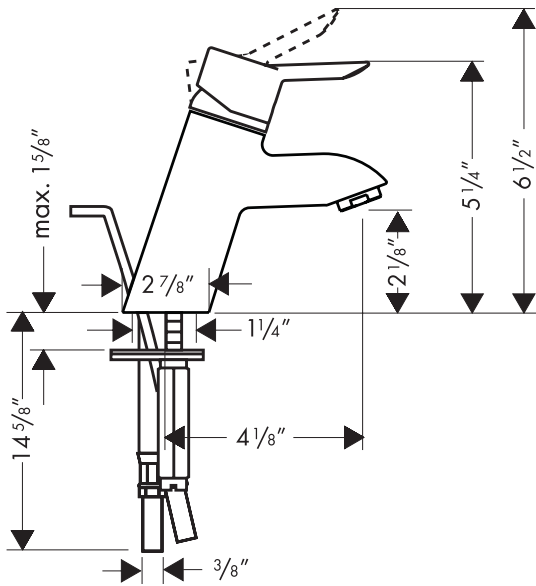

The measurements shown are for reference only.

Products and specifications shown are subject to change without notice.

Specification sheet revised 2/2008